

# Workbays

Ronan & Erwan Bouroullec, 2012

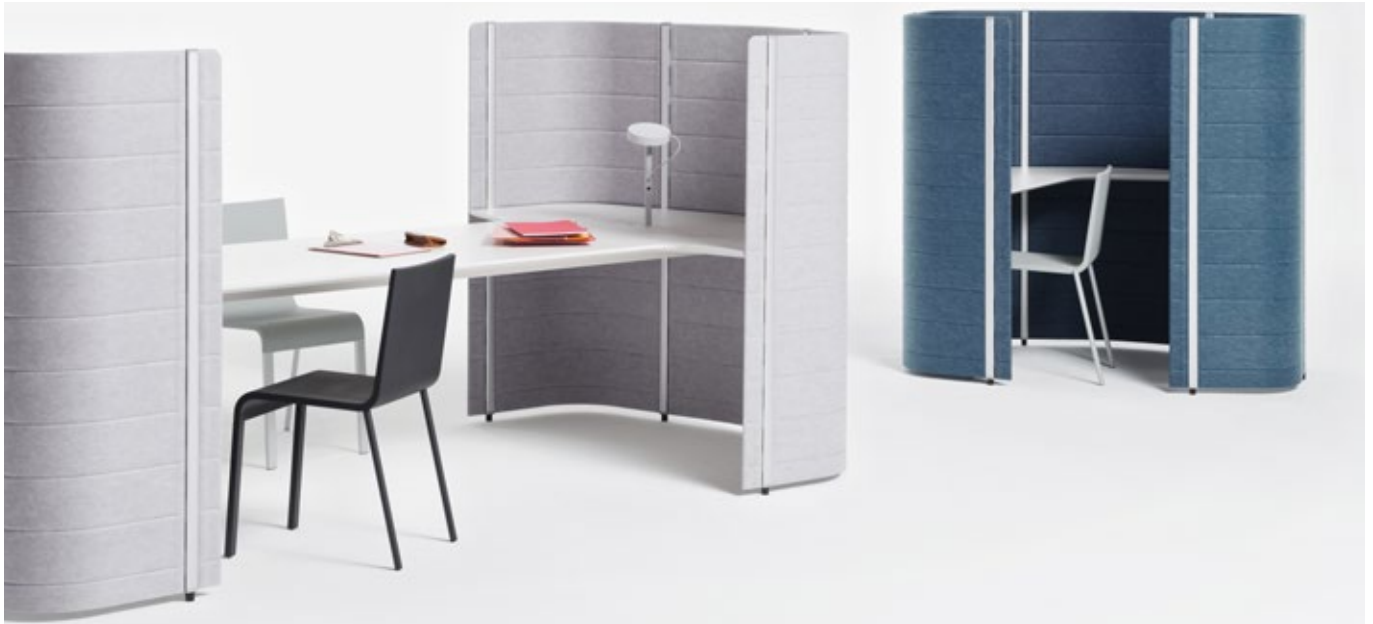

Workbays

With Workbays, Ronan and Erwan Bouroullec have developed a micro-architectural system that redefines the working environment and breaks with the typical rigid planning structure of offices. Yet Workbays not only provide office planners with a simple, multifunctional furniture system. They also offer employees the freedom to seek out the optimal environment for the task at hand. Workbay configurations fall into three categories:

- Workbays Focus provide places to withdraw for concentrated work;
- Workbays Meet create areas for communication;
- Workbays Space form a room within a room for functional zones such as wardrobes, printer islands, kitchens etc.

Thus Workbays create distinct areas where individuals or groups can retreat from the general office environment to carry out specific activities. The units come equipped with everything users need: work surfaces, seating and optional storage and power connections. Workbays respond to the necessity for noise reduction, helping to absorb disruptive sounds in the surrounding environment. They can spontaneously serve as telephone booths, video conference rooms, reading corners, quiet spots for a coffee break or meeting rooms – without sending participants behind closed doors.

Subtle yet striking, the organic forms of Workbays add definition and structure to a room. Workbay installations are easy to plan and can be integrated into virtually any space. They can be combined, expanded or adjusted as needed to meet changing conditions. Versatile and lightweight, the units are simple to install anywhere in the room – with no noise, no mess and no physical alterations to the building.



## Ronan & Erwan Bouroullec

The brothers Ronan and Erwan Bouroullec live and work in Paris. Their oeuvre ranges from small everyday objects up to architectural projects. They have worked with Vitra since 2000 and have contributed numerous designs to both the office and home collections.

1	Workbays	12-13	Table tops, electrification	21-23	Meet dimensions
2-9	Configurations	14-15	Seat upholstery	24-25	Space dimensions
10-11	Useful facts, acoustics, maintenance, connectors	16-17	Shelving, storage	26	Surfaces, colours
		18-20	Focus dimensions		



**Focus 1 low 15/10**

provides a single workspace for concentrated tasks and fits into almost any space with a footprint of just 1.65 m<sup>2</sup>.

**Components:** wall panels in 82 grey/stone, silver connectors, table top in soft light, Port 120 in soft light; Tip Ton chair: white



**Focus 1 high 15/20**

provides a single workspace for concentrated tasks. High walls ensure maximum visual and acoustic privacy.

**Components:** 18 sea blue wall panels, silver connectors, table top in soft light, Port 180 in soft light; Physix chair: aluminium base powder-coated in soft grey, TrioKnit seat fabric in silver



**Focus 1 high 12/10 2-cluster side**

provides for a temporary change of scenery. The high version with a small stand-up desk surface brings additional variation and movement to work activities – serving as a telephone booth, for example.

**Components:** 46 granite grey wall panels, connectors in deep black, table top in basic dark, Port 120 in basic dark; Tabouret Haut stool: dark oak



**Focus 1 medium 12/10 2-cluster front**

Focus 1 12/10 is exclusively offered in cluster configurations. In addition to the narrower side clusters, facing front clusters provide sheltered, compact workspaces.

**Components:** 82 grey/stone wall panels, silver connectors, table top in soft light, Port 120 in soft light; Softshell chair: four-star base in polished aluminium, Moss cover fabric in matte blue/blue



**Focus 2 medium 12/20**

enables two people to simultaneously work side by side.

**Components:** 09 green wall panels, connectors in silver, table top in soft light, Port 180 with polished finish; Chair: Standard SP



**Focus 1 medium 15/30**

provides a temporary workspace as well as a seat bench to accommodate 1-2 visitors.

**Components:** 09 green wall panels, silver connectors, table top in soft light, Port 180 with polished finish; benches covered with Laser fabric in stone grey; Physix chair: aluminium base powder-coated in soft grey, TrioKnit seat fabric in silver



**Focus 1 high 30/40**

is an open office within the office. The desk top is large enough to share with visitors and perimeter shelving provides additional storage surfaces.

**Components:** 82 grey/stone wall panels, silver connectors, table top in soft light, Port 180 with polished finish; Visavis 2 chairs: chrome-plated base, leather seat cover in asphalt



**Cluster of 3 Focus Workbays**

Lateral linking elements allow the formation of narrow, infinitely extendable configurations that are well suited for unused corridors or central zones.

**Components:** 18 sea blue wall panels, silver connectors, table tops in soft light, Ports in soft light; Tip Ton chairs: glacier blue

**Meet 2 medium 10/20**

is a space-saving solution for discreet one-on-one conversations. The compact size of these units allows them to be combined with permanent workstations, where they create small communication islands in direct proximity to fixed workspaces.

**Components:** 46 granite grey wall panels, silver connectors, table top in soft light, Port 180 in soft light; benches covered with Laser fabric in stone grey

**Cluster of 2 Meet Workbays**

Workbay units of the same height and colour can be joined into a cluster: this example shows Meet 4 medium 15/20 and Meet 4 medium 15/35.

**Components:** 82 grey/stone wall panels, silver connectors, table tops in soft light, Port 180 with polished finish; benches covered with Laser fabric in stone grey; .03 chairs: base powder-coated in silver, grey shell



**Meet 8 medium 15/40**

creates a space with the comfort of sofa-style lounge upholstery for informal meetings of up to 8 people.

**Components:** 09 green wall panels, silver connectors, seat benches covered with Laser fabric in green



**Meet 12 high 30/40**

provides seating for up to 12 persons or can be optionally equipped with a platform shelf for video conferences or team meetings.

**Components:** 18 sea blue wall panels, silver connectors, 1 platform shelf in soft light, Port 180 in soft light; benches covered with Laser fabric in dark blue

**Space Printer Area high 15/40**

creates a niche for free-standing equipment and offers specially shaped shelves that accommodate small printers, supplies etc.

**Components:** 82 grey/stonewall panels, silver connectors, shelves in soft light, Port 180 in soft light

**Space Service Point high 15/40**

serves as a practical place for spontaneous meetings and can be configured with 4-6 storage cabinets.

**Components:** 18 sea blue wall panels, silver connectors, shelves in basic dark, Port 180 in basic dark





**Space Wardrobe high 15/40**

is outfitted with lockers and an open wardrobe to offer storage options for staff and visitors.

**Components:** 09 green wall panels, silver connectors, shelves in soft light



**Space Room high 30/40**

serves as a separate 'room within a room'. It can be equipped with 2-5 perimeter shelves to provide ample storage area.

**Components:** 46 granite grey wall panels, connectors in deep black, shelves in basic dark

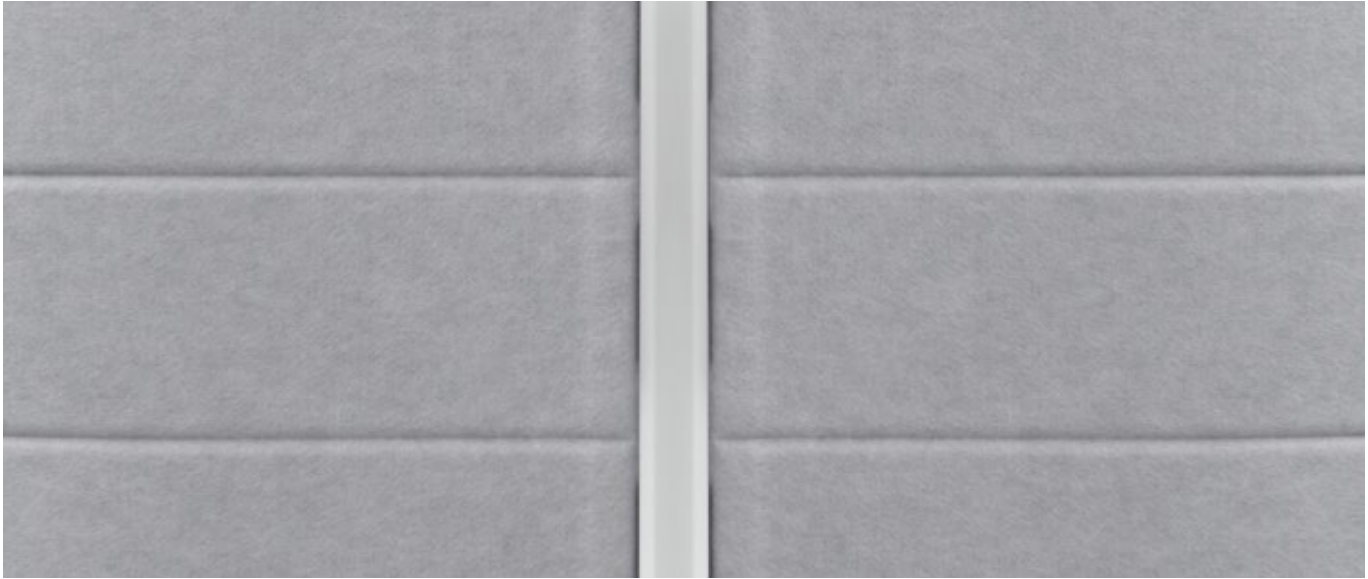

## ACOUSTICS

The structure of Workbays consists of slim aluminium profiles and organically shaped wall elements made of pressed polyester fleece. The use of this light and robust material is a groundbreaking innovation in the furniture sector. It helps to reduce noise and gives the office furniture system an inviting visual look and appealing textile feel. Slender in appearance yet remarkably sturdy and stable, Workbays are available in a range of colours.

Along with comfortable climate and lighting conditions, good acoustics is one of the most important factors of well-being in the workplace. Office designers

typically address this aspect with special acoustic products such as ceiling panels. But office furnishings with sound-absorbing properties can also make a significant contribution. The effectiveness of sound-absorbing elements depends on their material, thickness and area within the given space. A series of comparative measurements were carried out for Workbays.

In a partition simulation, the reverberation time was reduced by an average of 65 percent in the relevant frequency range of 200-2000 Hz. At 500 Hz, for example, the reverberation time in an empty room came

to approximately 4.0 seconds (reverberation similar to a swimming pool); with partition elements, the figure was reduced to approximately 1.5 seconds. This is a comfortable level for a conference room.

Straight, individual polyester fleece elements reduce the perception of noise in a room by approximately 50 percent, meeting the levels for sound absorption class D, despite their thin 12 mm wall structure.

## MAINTENANCE

Made of pure polyester in various colours, Workbay wall panels are thermoformed by the application of heat and pressure. Despite the thin wall structure (12 mm), they retain their shape and effectively reduce ambient noise. All elements are three-dimensionally moulded and articulated with a linear grid at intervals of 13 cm.

### Simple maintenance

Workbay wall panels are easy to clean and maintain. The fine-pored, relatively non-absorbent surface of polyester fleece

prevents liquids from immediately penetrating the fibres. Stains can be avoided by quickly wiping the surface with a damp cloth before liquids have a chance to soak in.

Recommendations for maintenance:

- Vacuum regularly (no brush attachment) and always treat stains as quickly as possible.
- Blot liquid spills.
- Remove dried-on debris with a putty knife or apply a very soft brush in the direction of the fibres.

- Commercially available dry foam is suitable for stain removal.

### Fire resistance

The polyester fleece walls have been tested in accordance with the European DIN EN 13501-1 classification for building materials, under which it meets 'B-s2, do' fire resistance standards (low flammability). Flame-retardant foams are used for bench upholstery.

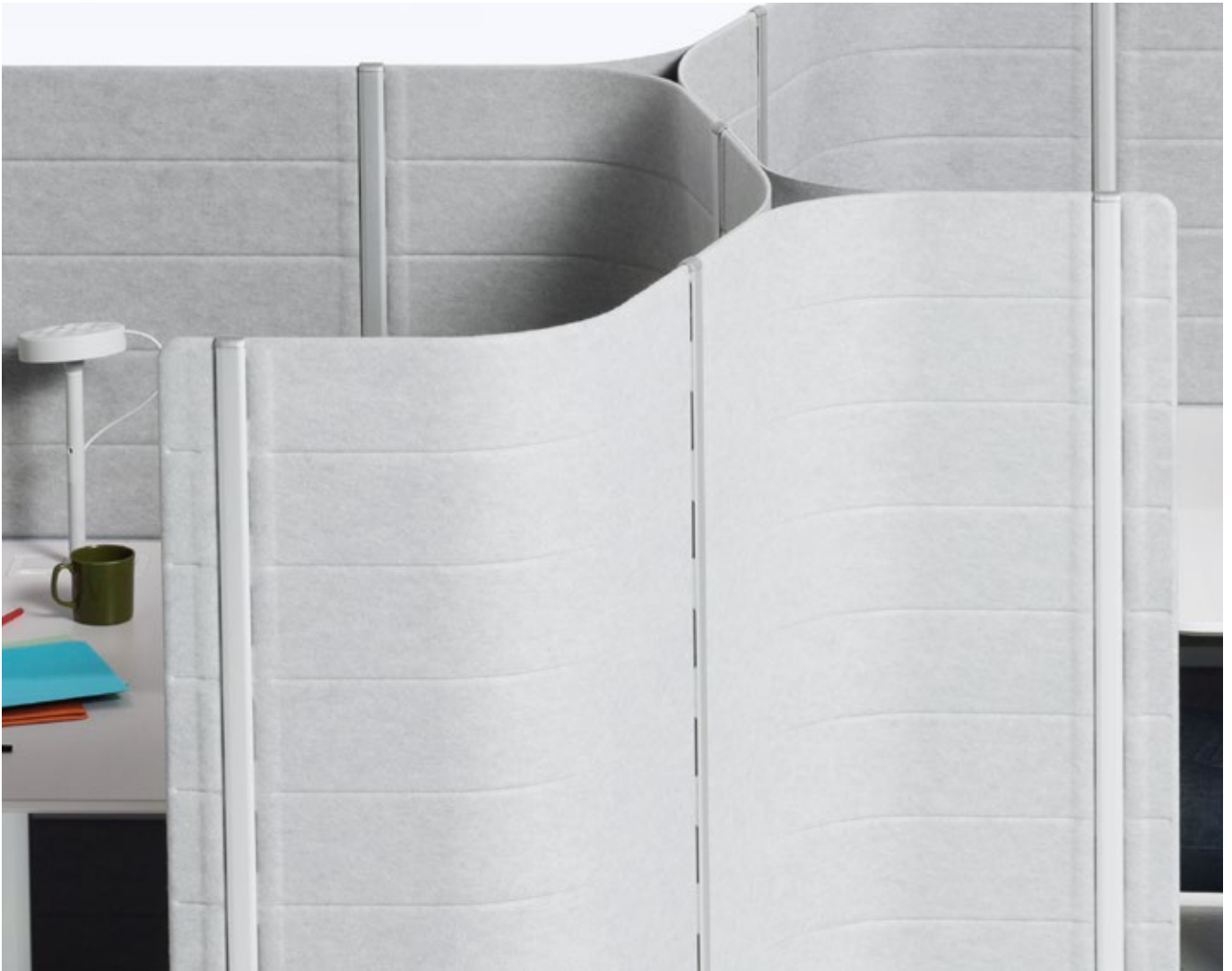

The patented connecting elements and structural design of Workbays ensure quick and easy assembly. All panels and aluminium connectors have an interlocking 130-mm grid along their sides, providing a lock-and-key system for adjoining elements. This makes it possible to assemble the walls of Workbays piece by piece. Only one screw per connector is necessary to secure the top and hold the wall elements in a stationary position.

In addition to their use as individual units, Workbays can be joined together to form clusters. Single wall panels are replaced by Y-elements, which attach the products firmly together to create diverse Workbay configurations that can define internal traffic patterns and guidance systems, thereby restructuring the space in the office.

Since the clusters have shared wall panels and profiles, Workbay products can only be combined if they have the same height and colour. Clusters are not offered in the Price List due to the great variety of possible combinations. However, it is possible to order Workbay clusters directly from Vitra without requesting assistance: simply order single Workbay units from the Price List along with additional Y-elements in the corresponding colour and height, or use the VCS planning software.

**MDF soft light**

table thickness 25 mm  
front edge chamfered at 65° angle

**MDF basic dark**

table thickness 25 mm  
front edge chamfered at 65° angle

**UNDER-TABLE TRAY**

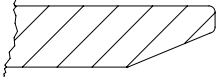
The open under-table tray made of polyester fleece provides a practical storage compartment for personal items. It is attached directly underneath the table top.

Under-table trays are available in the same colours as Workbay wall panels.

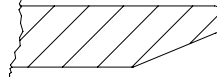
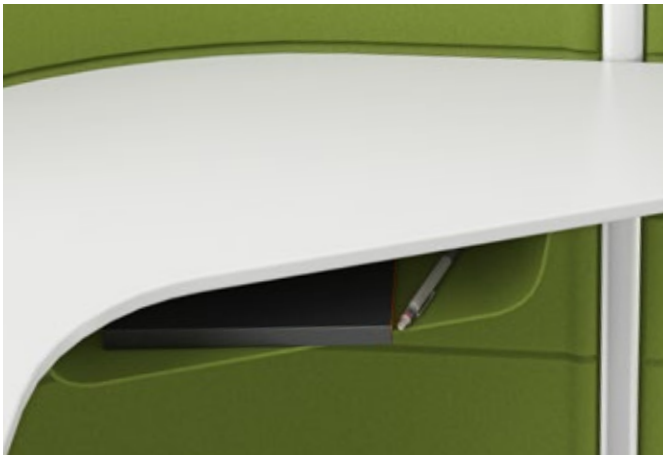
**MEET 12 PLATFORM SHELF**

Workbays Meet 12 30/40 comes fully upholstered with seating for up to 12 people or with 1-2 optional platform shelves. These replace the outermost upholstery elements and can be used to store books, utensils, monitors or video conference equipment, as shown here. Each platform shelf is equipped with a Port 180 hub for table-top electrification.



Port 120 provides a single power outlet and an attachment point on one side for accessories.



Port 180 provides two power outlets and a central attachment point for accessories.



Port 180 equipped with power and data connections.



The U-Turn table light by Belux can be directly attached to all versions of Port.

### CABLE TRAY AND CABLE CLIPS



Workbays provide simple solutions for cable management. A cable tray made of polyester fleece conceals the underside and distribution block of the Port hub and holds excess cable. The optional cable tray is always matched to the colour of the wall elements. Cables are routed directly from the Port outlet to the floor via cable clips which attach to the vertical wall connectors.

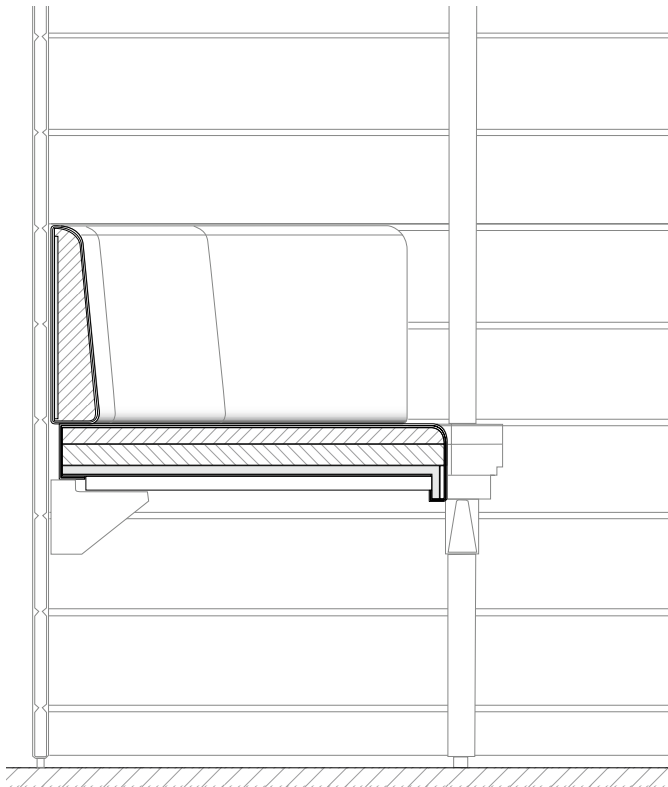

Work upholstery is used for Workbays Meet 2 10/20 and Meet 4 15/20. The firmer padding provides supportive seating for work-oriented activities around a table. It is composed of a 50 mm thick backrest cushion with a 5 percent slant and a 50 mm thick foam seat cushion. The height of the seat is 47 cm.

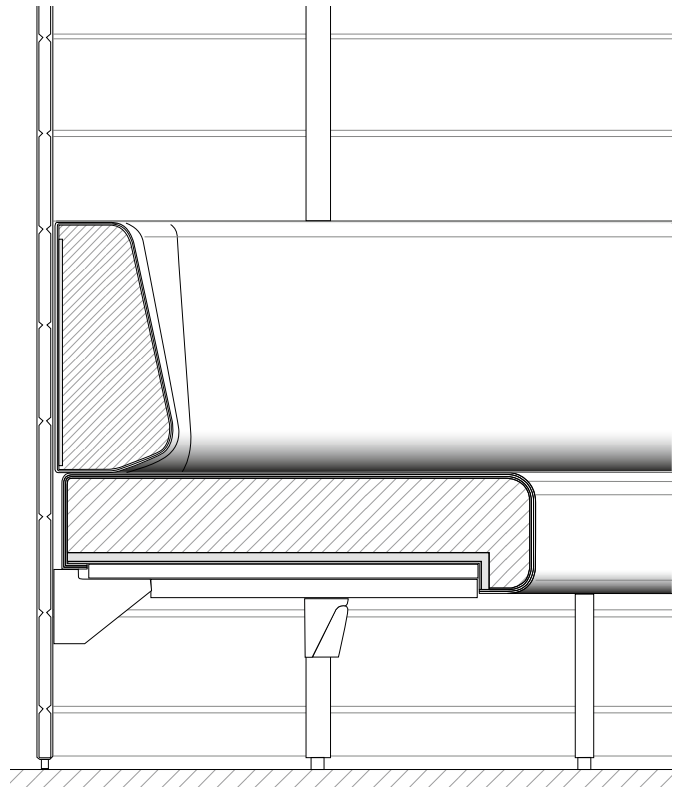

Lounge upholstery is used for Workbays Meet 8 15/40 and Meet 12 30/40. The softer padding allows the sitter to lean back and sink into the cushioning. The upholstery is composed of a 150 mm thick backrest cushion with a 12 percent slant and a 100 mm thick foam seat cushion. The height of the seat is 40 cm.



Workbay benches are comprised of four main parts: frame, substructure, backrest and seat cushion. Seat upholstery is made of flame-retardant polyurethane foam and covered with Laser fabric.

Meet 2 12/20 and Meet 4 15/20 benches are connected to the aluminium profiles with special brackets, making additional leg supports unnecessary.

Meet 8 15/40 and Meet 12 30/40 benches are additionally supported by black legs due to the longer span of their seat surfaces.

## UNDER-SEAT SOCKETS



Workbays Meet configurations without table elements – like Meet 8 15/40 and Meet 12 30/40 – can be equipped with power outlets beneath the seat. This enables users to charge their laptops, tablets and other devices while enjoying the relaxing ambience of a lounge-like setting.



By offering many different possibilities for shaping interior spaces, Workbays bring added value to any office environment. In addition to optional table elements and seat benches, continuous perimeter shelving is available for some Workbay units. These configurations are well suited as storage areas for individual users or

teams, but can also be used as veritable rooms for designated functions – such as a library, a multi-purpose or project-oriented display space, or as a conference room.

The Space Room 30/40 (pictured above) offers interior configurations that are especially suited for such purposes: the level of the top shelf is variable, as well as the number of shelves used. For example, a simple meeting space can be outfitted with two shelves at sitting and standing heights, or a library can be equipped with up to five levels of perimeter shelving.



### SHELVING

Workbays Space configurations always have at least two shelf levels around the interior perimeter. In the Space Printer Area high 15/40, the shelf surfaces on the sides are deep enough to accommodate compact table-top equipment while the long, narrow shelf elements leave adequate space for free-standing printers.



### WHITEBOARD

Magnetic whiteboards can be inserted between the vertical connectors of any straight wall panel – both on the interior and exterior sides of the Workbays.





Workbays Space Service Point high 15/40 and Wardrobe high 15/40 are equipped with storage lockers.

The wardrobe is outfitted with hanging rods and locker compartments to provide safe and easy storage for personal items that are not needed during office hours. The doors and sides of the lockers are available in soft light or basic dark to match the shelf surfaces. Each compartment is equipped with a combination lock, whose numerical code can be individually selected by the user.

The Service Point provides a work surface and four to six cabinet elements that can be used to store office supplies or kitchen utensils. Cabinet doors and sides are offered in the same surface materials as the shelves. The doors have no handles and operate with a push-to-open mechanism.



#### HANGING BOX

This powder-coated hanging box fastens onto the profiles of the straight wall panels and provides a space for documents and objects weighing up to 10 kg.

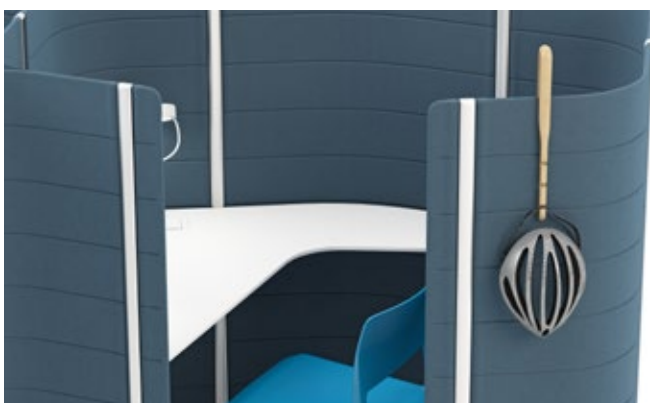

#### COAT HOOK

This coat hook made of natural-coloured solid oak holds up to four articles of clothing and can be attached to any type of panelling.

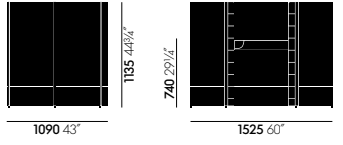
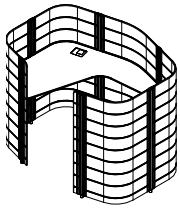

Workbay Focus 1 low 15/10

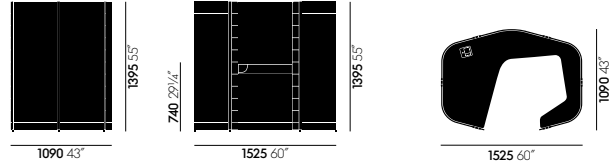
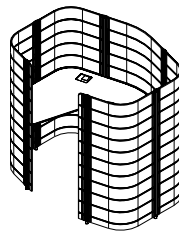

Workbay Focus 1 medium 15/10

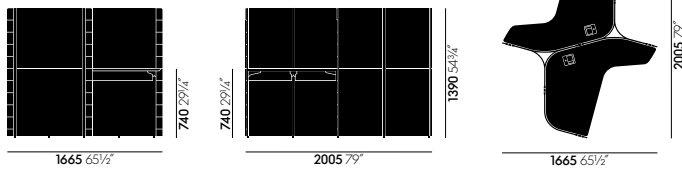
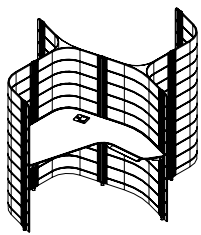

Workbay Focus 1 medium 12/10, 2-Cluster Front

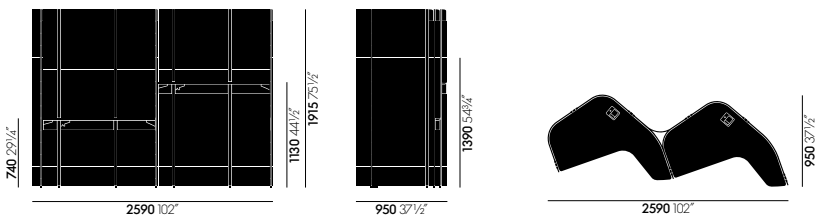
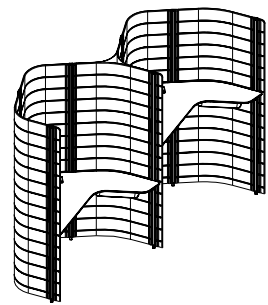

Workbay Focus 1 high 12/10, 2-Cluster Side

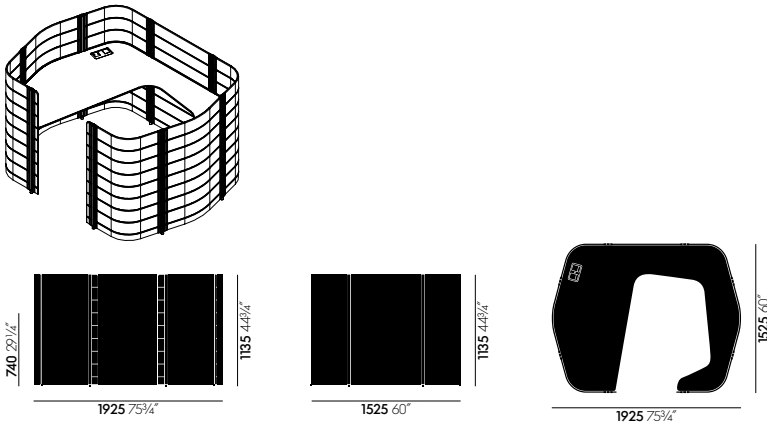

Workbay Focus 1 low 15/20

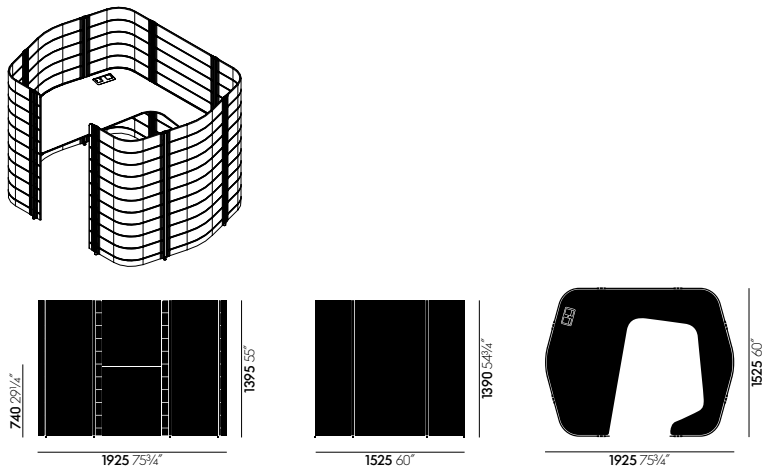

Workbay Focus 1 medium 15/20

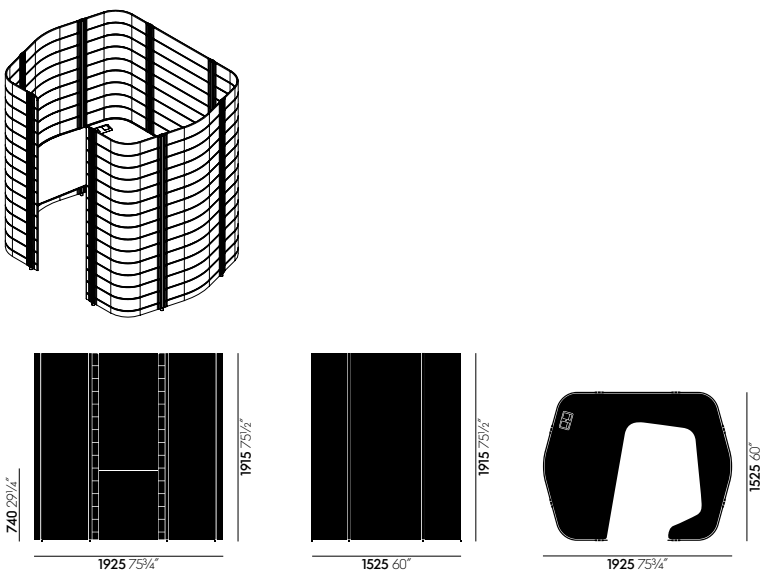

Workbay Focus 1 high 15/20

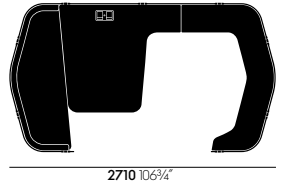
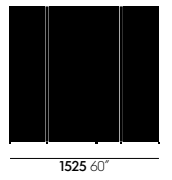
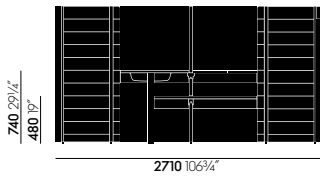
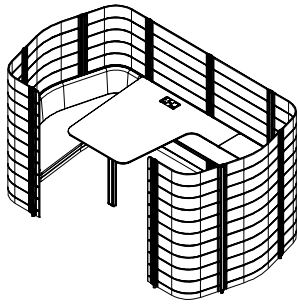

Workbay Focus 1 medium 15/30

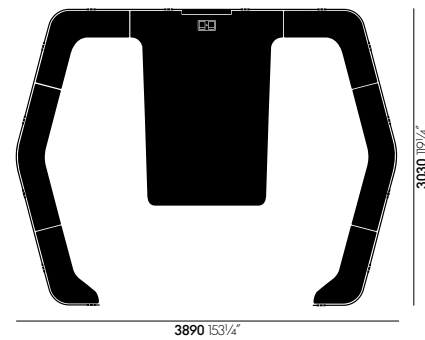
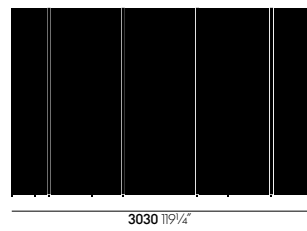
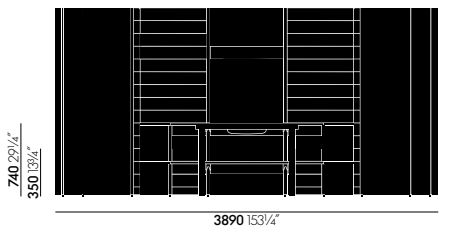
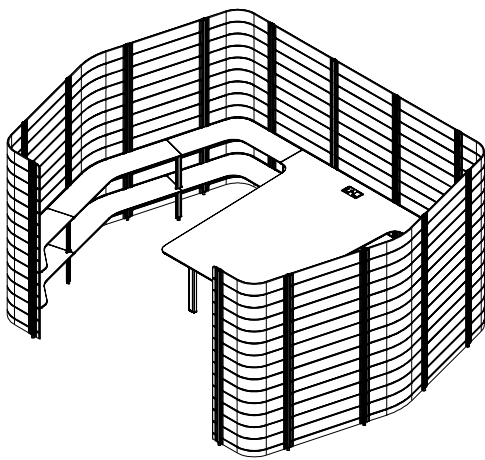

Workbay Focus 1 high 30/40

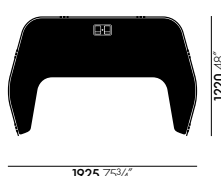
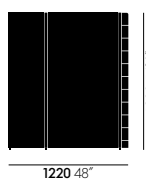
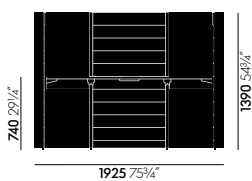
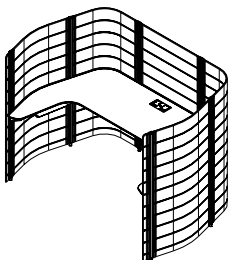

Workbay Focus 2 medium 12/20

MEET DIMENSIONS

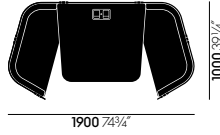
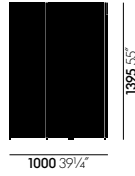
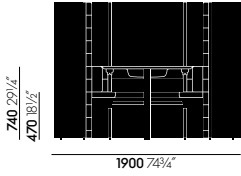
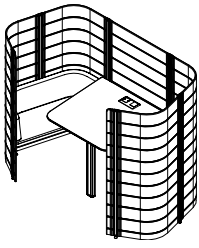

Workbay Meet 2 medium 10/20

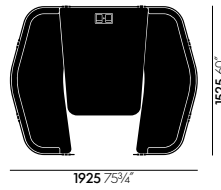
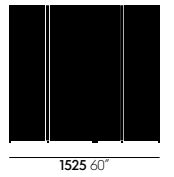
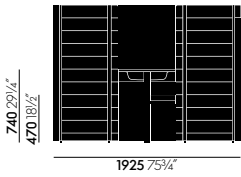
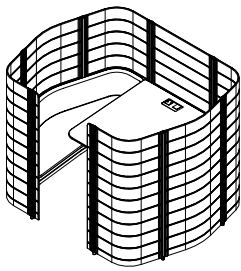

Workbay Meet 4 medium 15/20

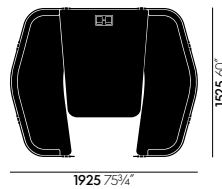
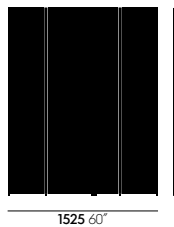
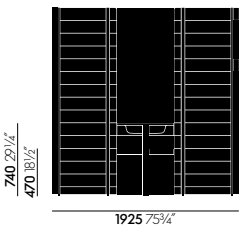
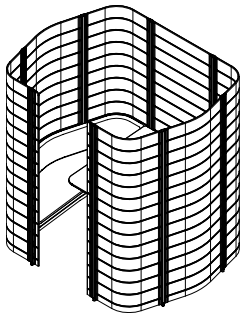

Workbay Meet 4 high 15/20

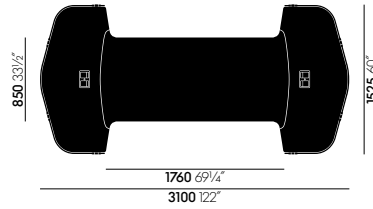
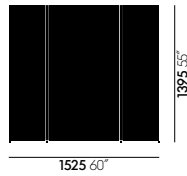
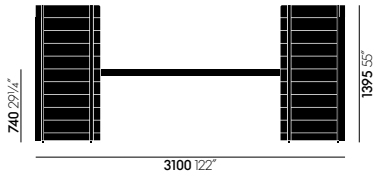
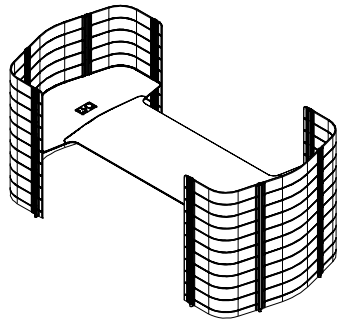

Workbay Meet 4 medium 15/35

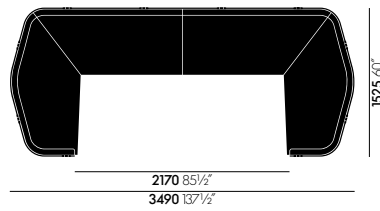
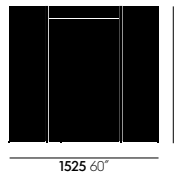
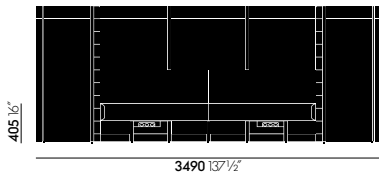
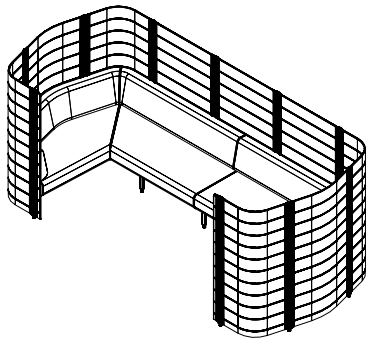

Workbay Meet 8 medium 15/40

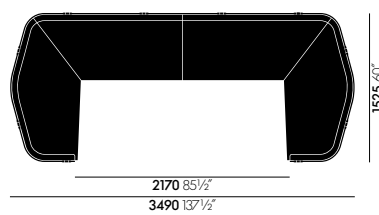
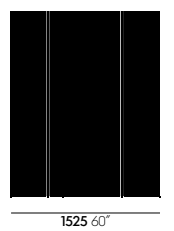
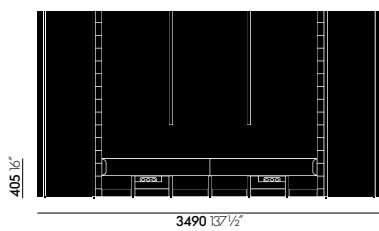
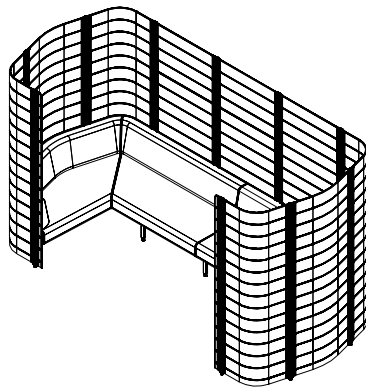

Workbay Meet 8 high 15/40

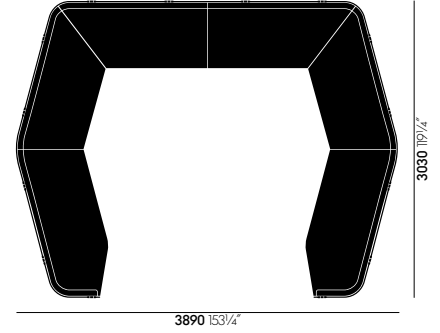
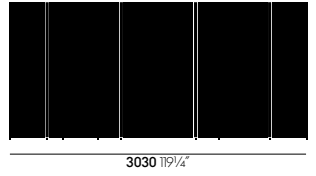
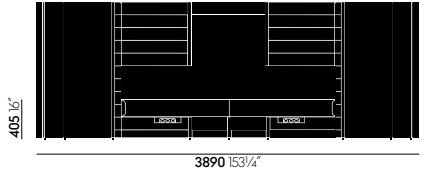
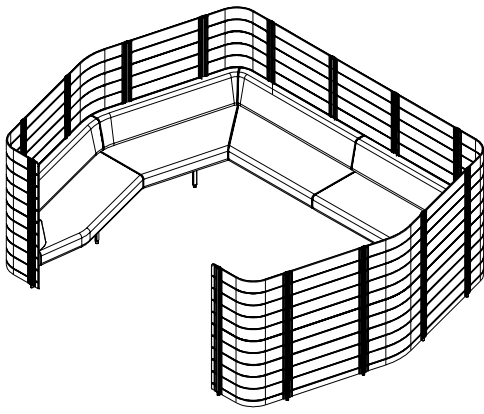

Workbay Meet 12 medium 30/40

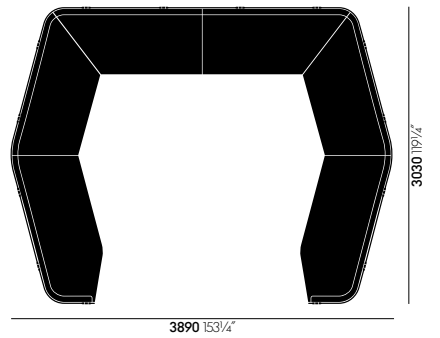
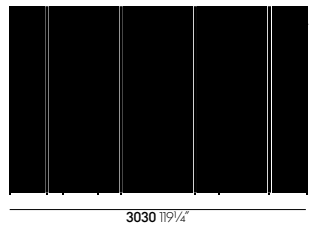
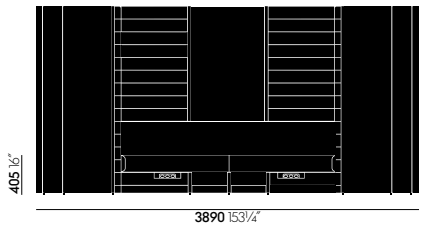
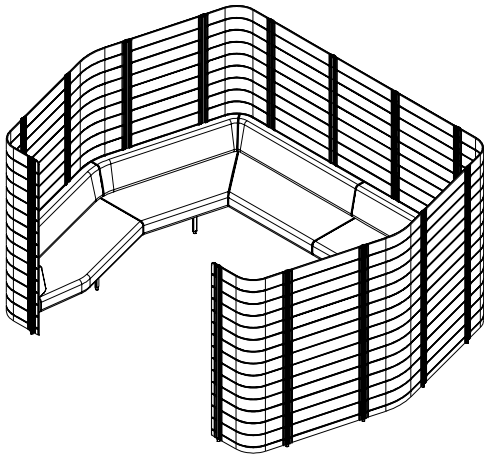

Workbay Meet 12 high 30/40

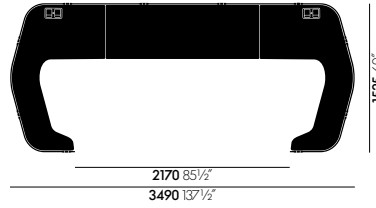
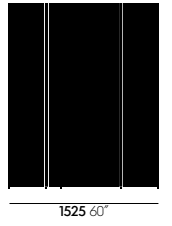
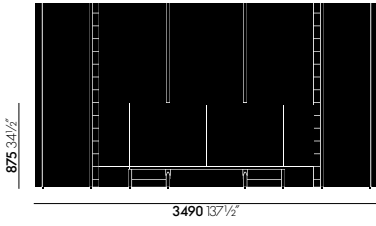
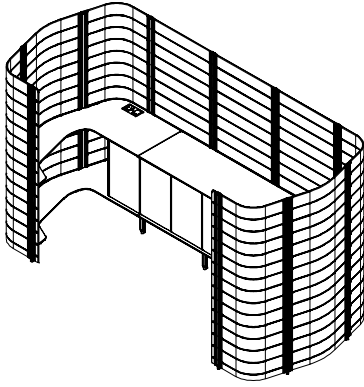

Workbay Service Point high 15/40

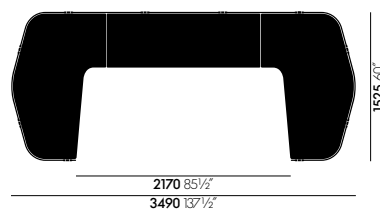
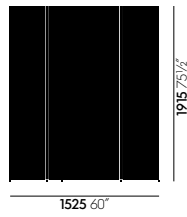
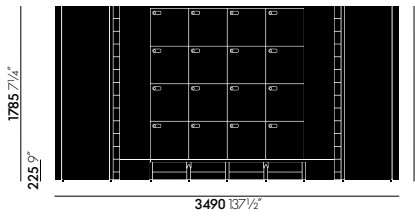
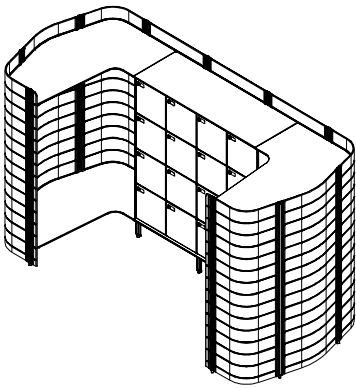

Workbay Space Wardrobe 15/40



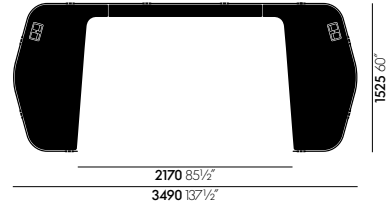
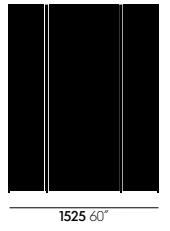
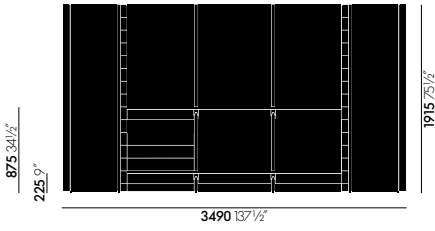
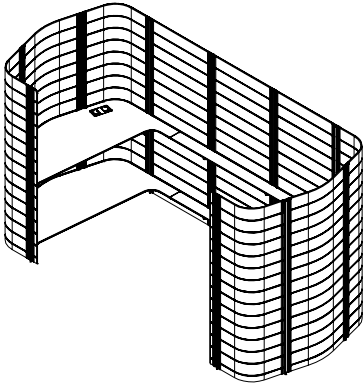

Workbay Space Printer Area 15/40

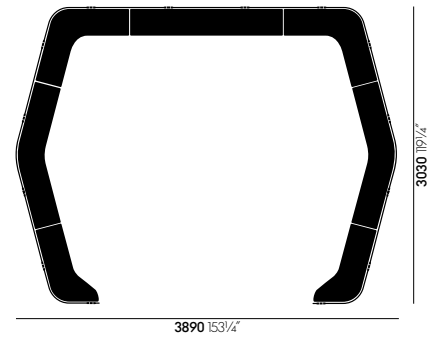
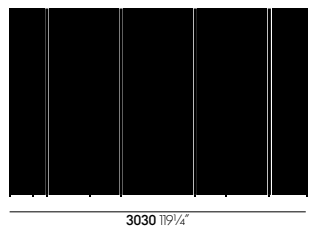
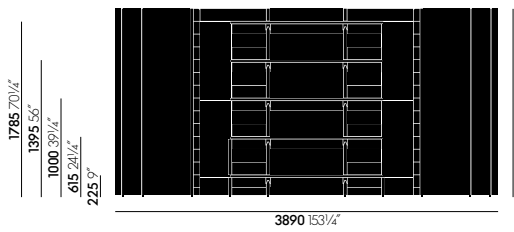
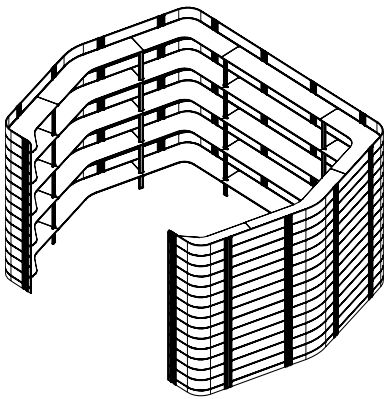

Workbay Space Room high 30/40

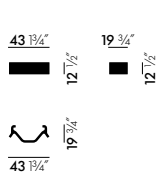

Cable clips

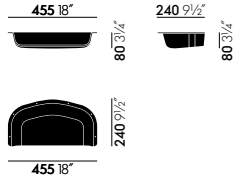

Under-table tray /  
Cable tray

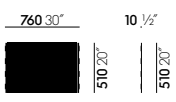

Whiteboard

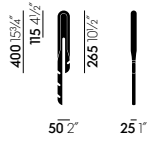

Coat hook

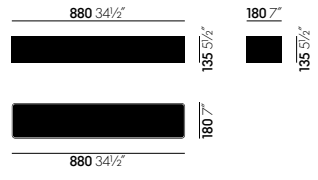

Hanging box



**Laser**

100% Trevira CS polyester | 520 gr/m<sup>2</sup>

With its distinctive woven structure, Laser makes a robust and striking cover fabric. The varied palette offers a wide selection of colours, with the duotones showing off the woven structure to even greater advantage. Practical and easy to care for, as well as durable and highly abrasion-resistant, Laser is also well suited for office environments.

Laser is available in 35 colours.

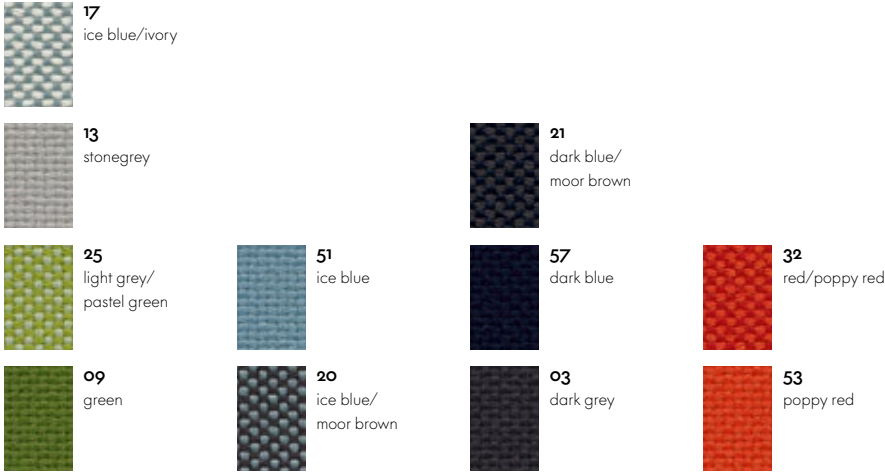

**Cover fabric upholstery, Laser**



**Wall panels**

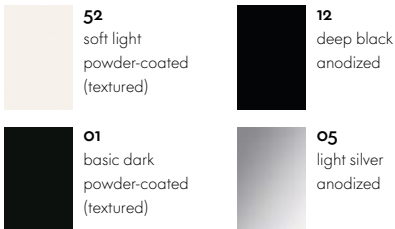

**Table tops and shelves MDF**

**Aluminium profiles**

